

LUXE

OLED PARTS GUIDE

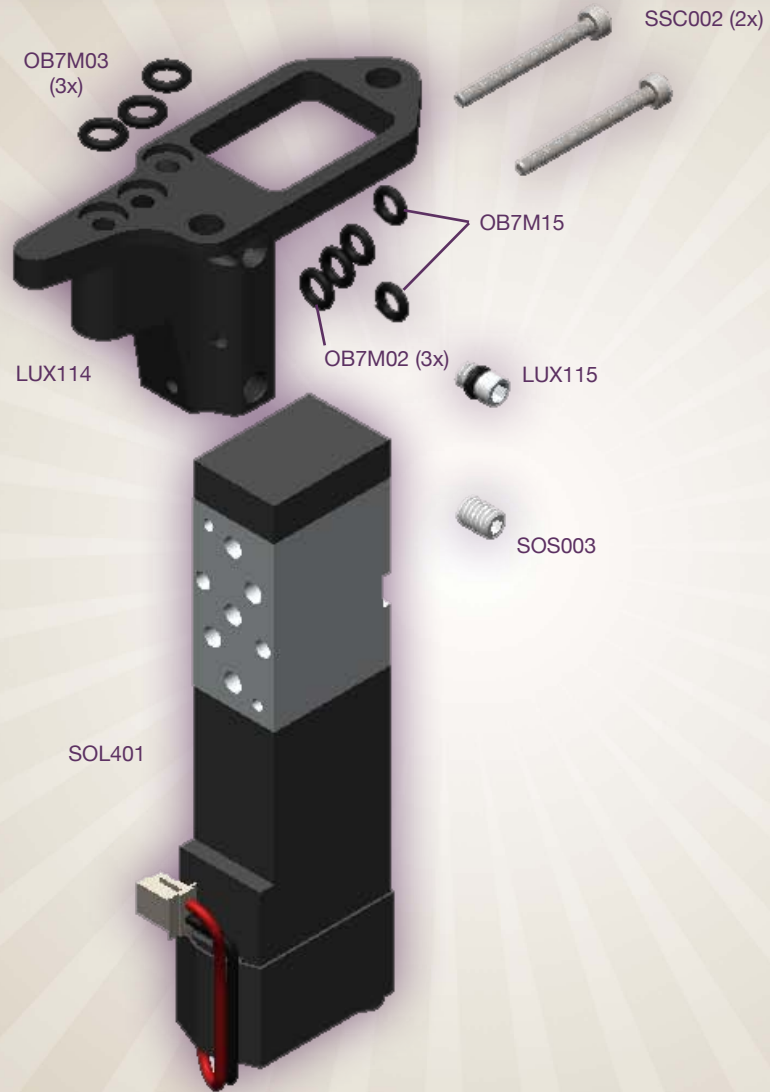

SOLENOID VALVE



DETENT ASSEMBLY

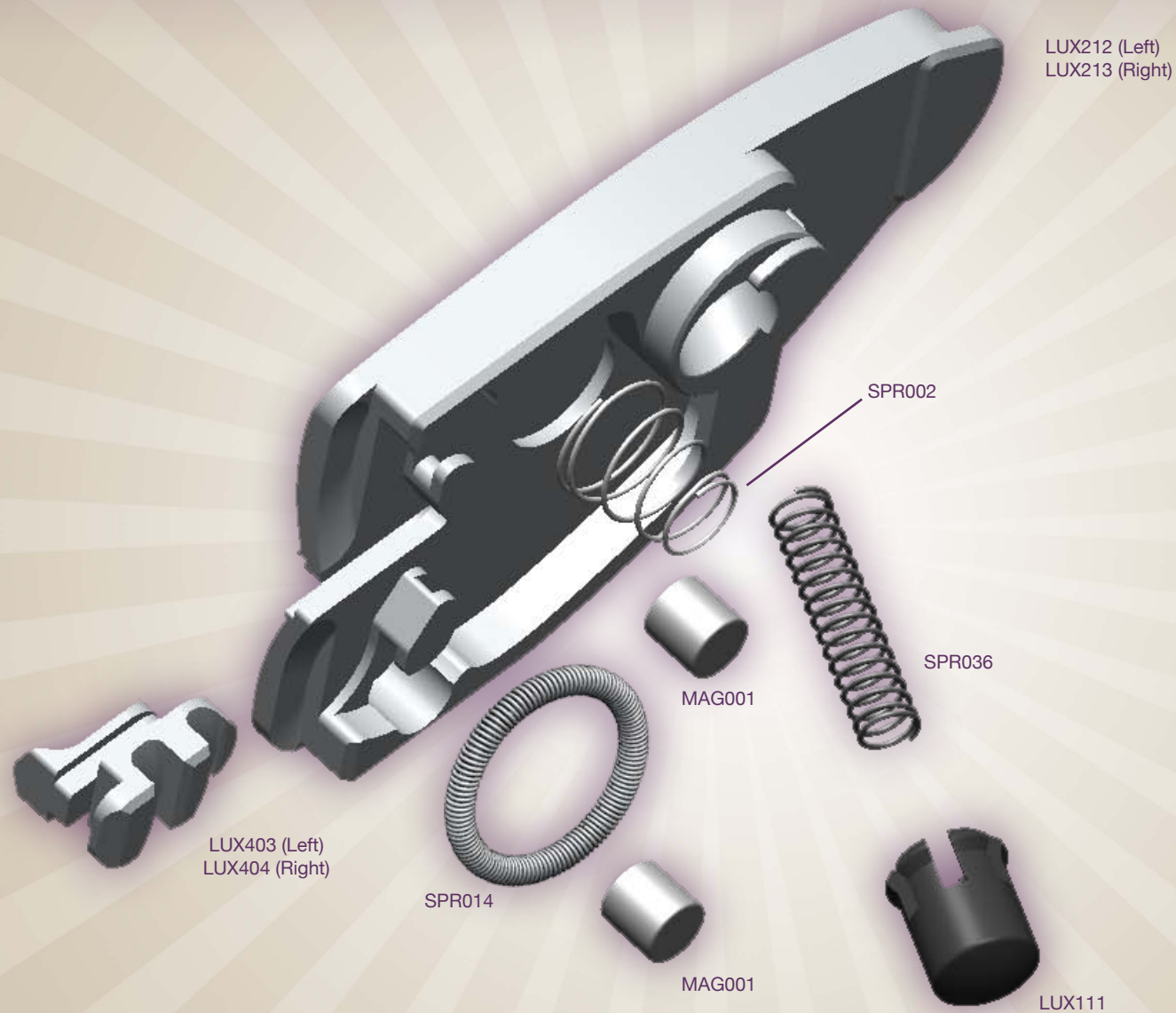

BARREL



LOCKING FEEDNECK

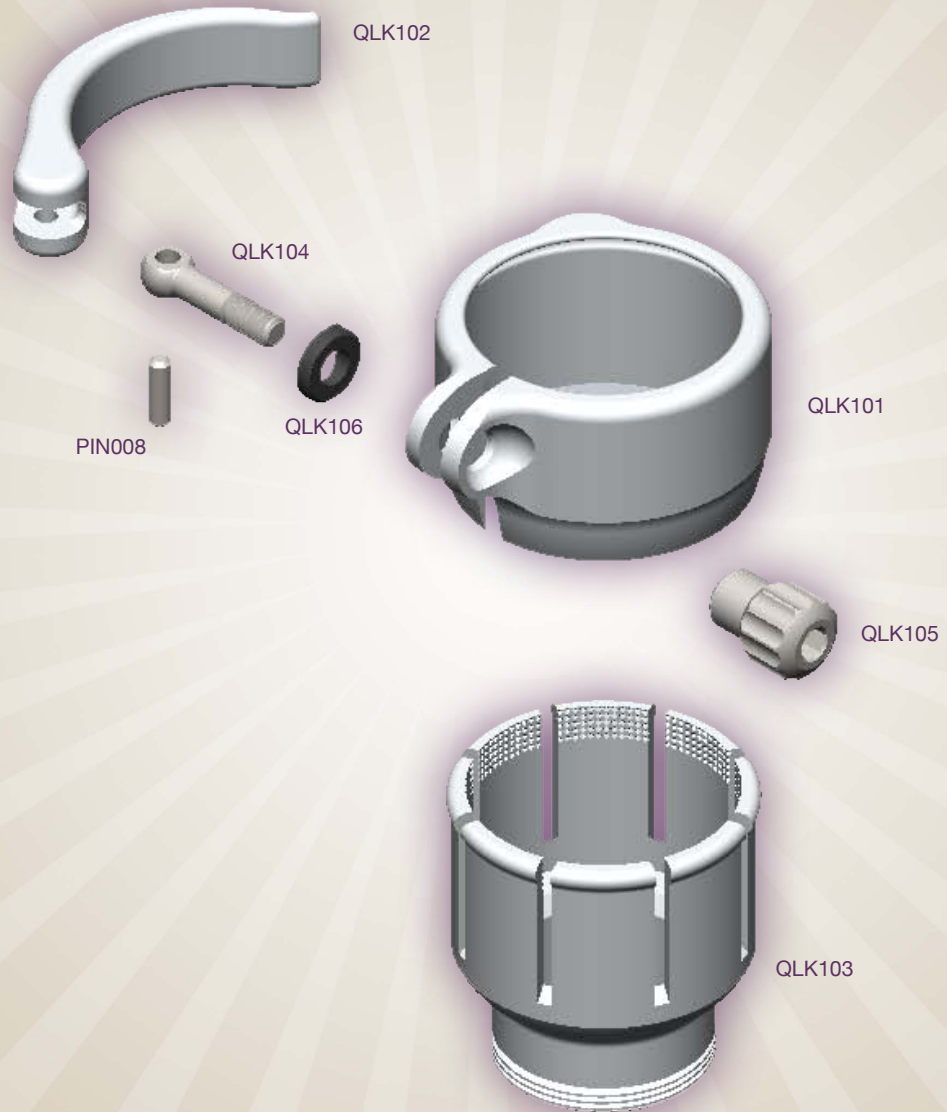

GRIP FRAME



TRIGGER



BOTTOM LINE

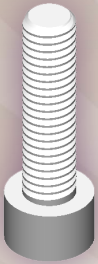

SSC014
Use for mounting Bottom Line on drop rail.
Always test fit mount screws with battery removed to ensure that screw does not protrude into grip frame where it may damage the LiPO battery.

SSC010 (2x)

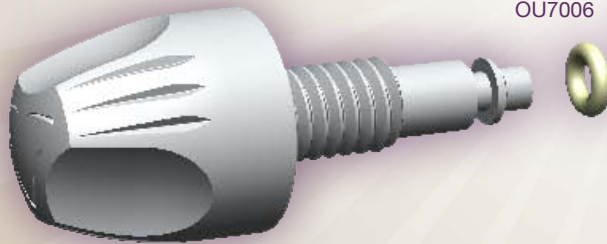
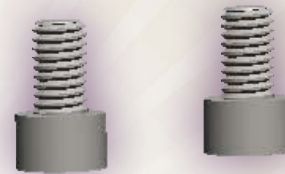

LUX137

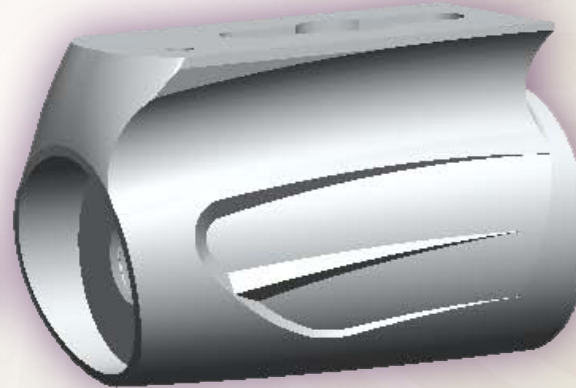

LUX136

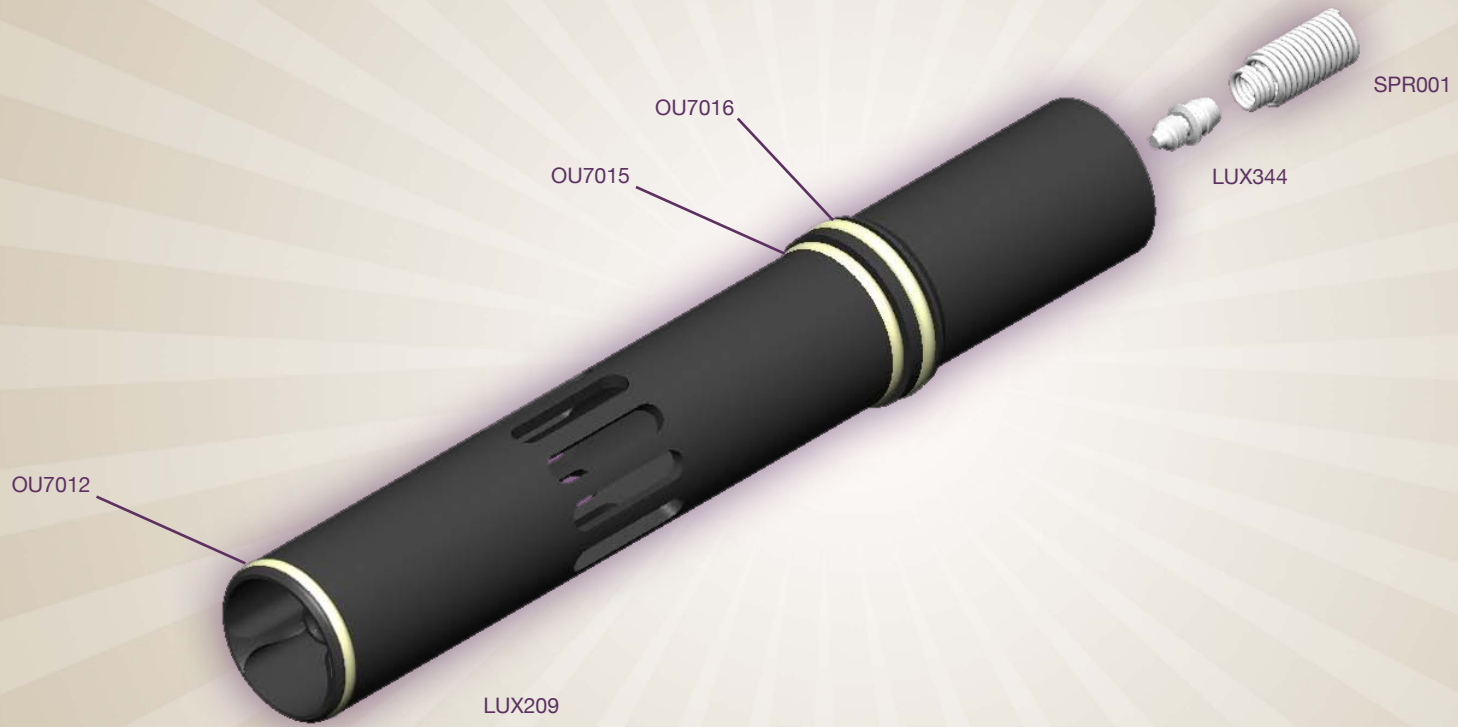

FIRING CHAMBER



BOLT GUIDE



QUICK-STRIP



REGULATOR

